



Passerelle acier 2m

Code : N221-001

85 kg

EN 12811

Charge max. : 1,5 kN/m²

Rangement alterné des passerelles

5 pcs



→ 445 kg

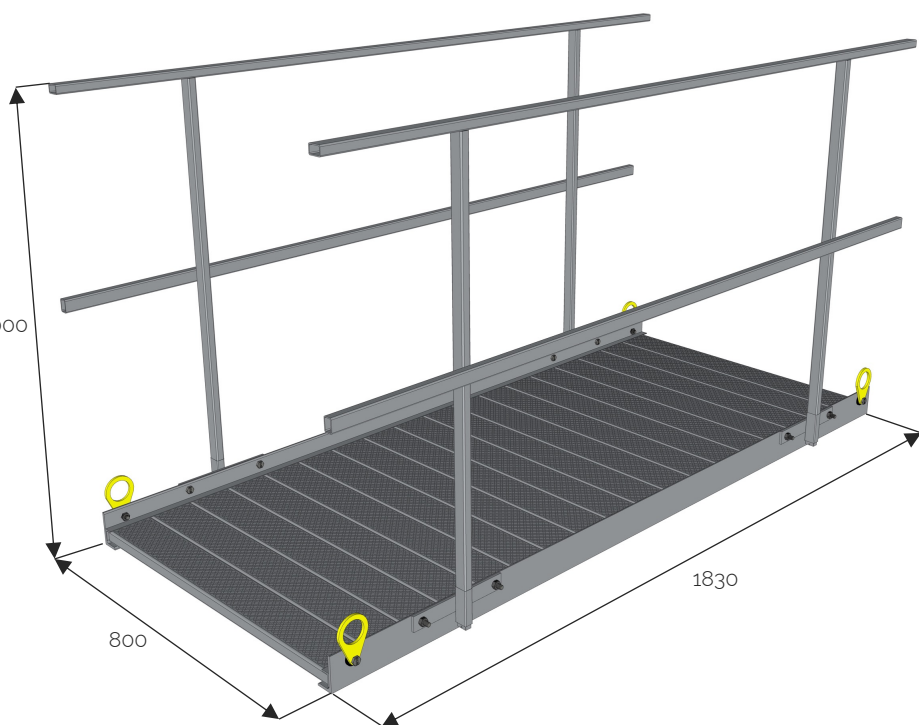

[mm]

