

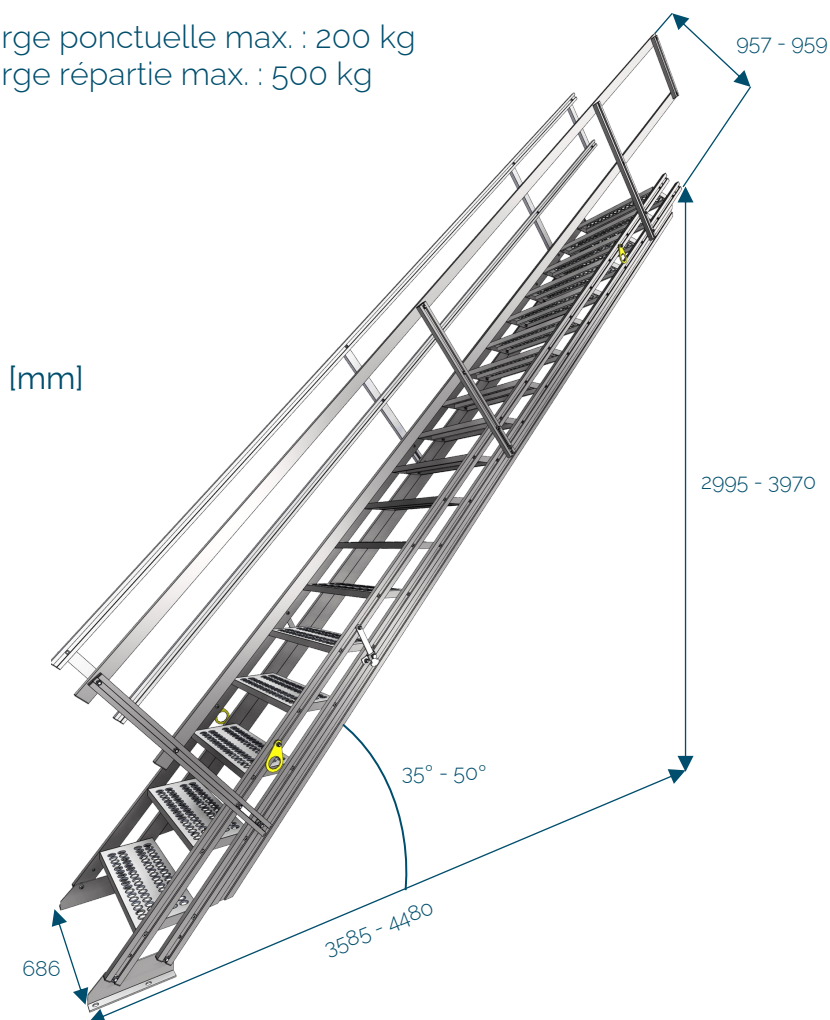

Escalier 18 marches Aluminium

Charge ponctuelle max. : 200 kg
Charge répartie max. : 500 kg

Code : V213-006
131,7 kg
EN 12811-1:2003



Installation sur talus

1	Piquets 5 x 5 cm (obligatoire)	8 pcs
2	Élément porteur ~10 x 5 cm (recommandé)	3 pcs
3	Élément d'arrêt (obligatoire)	1 pc

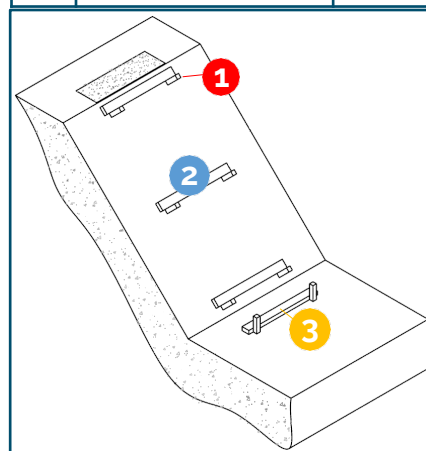

Composants

V214-025	Marche simple aluminium	17 pcs		Garde-corps	2 pcs
V214-026	Marche palière aluminium	1 pc	V214-029	Mécanisme de verrouillage	2 pcs
V214-027	Pied gauche	1 pc	N212-025	Anneau de levage	4 pcs
V214-028	Pied droit	1 pc		Fixation de dalle	2 pcs

