

USER'S MANUAL

HAKI UNIVERSAL

Suspended scaffolding



Important information

HAKI's product liability and user's manuals apply only to scaffolds that are entirely composed of components that have been made and supplied by HAKI.

HAKI's scaffold systems must not be erected using components of makes other than HAKI or be connected to scaffolds of makes other than HAKI. In such cases, a special study of load-bearing capacity must be carried out. However, HAKI has no objection to the customary addition of scaffold tubes and approved couplers to the scaffold.

Adding components from different suppliers may invalidate the insurance cover.

This user's manual is based on a minimum of 2 competent erectors.

This user's manual is to be used in conjunction with HAKI training courses.













HAKI reserves the right to make technical modifications on a continual basis.

The latest versions of HAKI user's manuals can be downloaded from our website, www.HAKI.com.

For scaffold structures that are not covered by this user's manual, please contact HAKI's technical department.

HAKI colour code

Horizontals and diagonals are marked with their nominal sizes (bay sizes) and a colour code. The marking is a useful means of identification when erecting and handling the scaffold material.

564		1050		1964		3050	
700		1250		2050			
770		1550		2500			
1010		1655		2550			

Forces and dimensions

1000 N = 1 kN ~ 100 kg

10 N ~ 1 kg

All measurements in mm

HAKI Universal suspended scaffolding

Following examination by RISE, Research Institutes of Sweden, the scaffolding has been issued with a Type Examination Certificate in accordance with the requirements of Ordinance AFS 2013:4 and SS-EN 12810-1 and associated standards – Certificate No. 14 55 01.



General data

HAKI Universal suspended scaffolding is erected with various bay widths and normally with a bay length of 3050 mm and a lift height of 2000 mm.

ERB and LB beams can be used both as ledgers and transoms.

HAKI decking units are suitable for use as decking.

Marking

All components with the exception of locking pins etc. come permanently marked with the HAKI logo or HAKI text, the first letter of the country of manufacture and the last two figures of the year of manufacture (S24).





All loadbearing components are marked for full traceability. For further information, please refer to the HAKI Safety Guide.



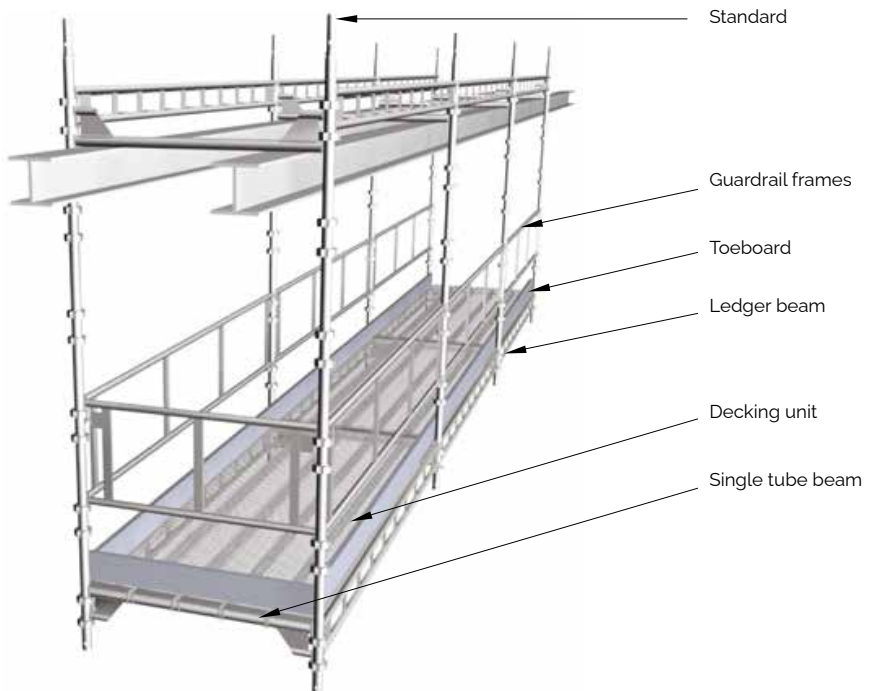

Suspension devices are stamped with the relevant WLL (SWL): 20 kN or 12 kN.







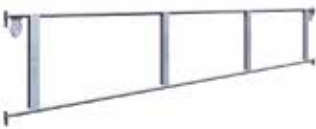

Older components that are covered by the certificate







Ledger beam LB, Standard FSSH and Guardrail frame SKRD.









Name		Code	Item No.	Weight
Standard S4 AL		S4 500	4017056	1.6
Standard joint with spigot Ø38 mm		S4 1000	4017106	2.8
Pockets at the same level		S4 1500	4017156	4.0
Ø 48 mm		S4 2000	4017206	5.2
Aluminium		S4 3000	4017306	7.7
Standard S		S 500	7016050	2.9
Standard joint with spigot		S 1000	7016100	5.3
Pockets at the same level		S 1500	7016150	7.7
Ø 48 mm		S 2000	7016200	10.1
		S 3000	7016300	15.2
Locking pin			5141257	0.3
Ø 16 mm For reinforcing standard joint in connection with tensile load, e.g. when scaffolding is suspended, when lifting or when scaffolding is used for temporary roof.				
Ledger beam LB AL		LB 700 AL	4021066	2.2
With spring locking catch		LB 770 AL	4021073	2.9
Ø 34 mm		LB 1050 AL	4021101	3.5
Aluminium		LB 1250 AL	4021121	4.2
		LB 1655 AL	4021161	4.8
		LB 1964 AL	4021191	5.8
		LB 2500 AL	4021246	7.2
		LB 3050 AL	4021301	8.5
Ledger beam LBL		LBL 1050	7021102	4.8
With spring locking catch		LBL 1250	7021122	6.5
Ø 34 mm		LBL 1655	7021162	6.7
		LBL 1964	7021192	8.0
		LBL 2050	7021202	8.5
		LBL 2500	7021252	10.9
		LBL 2550	7021257	11.2
		LBL 3050	7021302	12.3

Name	Code	Item No.	Weight
Single tube beam ERB AL With spring locking catch Ø 48 mm Aluminium 	ERB 564 AL	4022051	2.5
	ERB 700 AL	4022066	2.7
	ERB 770 AL	4022073	2.9
	ERB 1050 AL	4022101	3.2
	ERB 1250 AL	4022121	3.6
	ERB 1655 AL	4022161	4.1
	ERB 1964 AL	4022191	4.5
	ERB 2500 AL	4022246	5.4
ERB 3050 AL	4022301	6.2	
Single tube beam ERB With spring locking catch Ø 48 mm 	ERB 564	7022050	3.1
	ERB 700	7022066	3.3
	ERB 770	7022073	3.6
	ERB 1050	7022101	4.4
	ERB 1250	7022121	5.1
	ERB 1655	7022161	6.3
	ERB 1964	7022191	7.3
	ERB 2050	7022201	7.8
	ERB 2500	7022246	9.9
	ERB 3050	7022301	11.3
Guardrail frame SKRD AL With spring locking catch Aluminium 	SKRD 700 AL	4052066	3.3
	SKRD 770 AL	4052073	3.5
	SKRD 1050 AL	4052101	4.5
	SKRD 1250 AL	4052121	4.8
	SKRD 1655 AL	4052161	5.9
	SKRD 1964 AL	4052191	6.6
	SKRD 2500 AL	4052246	7.8
SKRD 3050 AL	4052301	8.9	
Guardrail frame GFL With spring locking catch Octagon 28 mm 	GFL 700	7052070	3.8
	GFL 770	7052077	4.0
	GFL 1050	7052106	4.9
	GFL 1250	7052124	5.7
	GFL 1655	7052164	7.4
	GFL 1964	7052194	8.1
	GFL 2500	7052254	9.2
	GFL 3050	7052304	10.5
Diagonal brace AL Aluminium Ø 48 mm 	DS 2500 AL	4122245	6.1
	DS 3050 AL	4122300	6.7
Diagonal brace With wedge couplers Ø 48 mm 	DS 1250	7122124	9.0
	DS 1655	7122164	10.1
	DS 1964	7122194	10.9
	DS 2500	7121254	12.6
	DS 3050	7121304	14.3

Name	Code	Item No.	Weight
Plan brace AL Aluminium Ø 48 mm 	HDS 3050x1655 AL	4141000	7.0
	HDS 3050x1250 AL	4141001	6.5
	HDS 2500x1250 AL	4141005	6.0
	HDS 2500x1655 AL	4141006	6.3
	<hr/>		
Plan brace telescopic AL Aluminium L=1960-3470 mm 	HDS AL	4141010	6.3
<hr/>			
Plan brace With wedge couplers Ø 48 mm 	HDS 3050x1655	7141000	13.8
	HDS 3050x1250	7141001	13.2
<hr/>			
AL-plank W=230 mm L=1010-1964 - Load class 6 (6.0 kN/m ²) L=2500 - Load class 5 (4.5 kN/m ²) L=3050 - Load class 4 (3.0 kN/m ²) 	ALP 1010x230x90	2158100	4.9
	ALP 1250x230x90	2158120	5.6
	ALP 1655x230x90	2158160	6.9
	ALP 1964x230x90	2158190	7.8
	ALP 2500x230x90	2158250	9.5
	ALP 3050x230x90	2158300	11.2
<hr/>			
HAKI Steel plank W=230 mm L=1050-3050 - Load class 6 (6.0 kN/m ²) 	SPL 1050x230x90	21521050	6.9
	SPL 1250x230x90	21521250	7.6
	SPL 1655x230x90	21521655	9.7
	SPL 1964x230x90	21521964	11.8
	SPL 2500x230x90	21522500	14.6
	SPL 3050x230x90	21523050	17.7
	<hr/>		
Toeboard AL 	564 AL	4161051	1.0
	700 AL	4161071	1.3
	1050 AL	4161105	1.9
	1250 AL	4161121	2.2
	1655 AL	4161161	2.9
	1964 AL	4161191	3.5
	2500 AL	4161251	4.6
	3050 AL	4161301	5.5
<hr/>			
Bracket AL Without spigot With spring locking catch Ø 48 mm Aluminium 	SK 230 AL	4211024	1.7
	SK 460 AL	4211047	1.9
<hr/>			
Bracket with spigot AL With spring locking catch With spigot Aluminium 	SK 564 AL	4211052	3.6
	SK 770 AL	4211074	3.9

Name		Code	Item No.	Weight
Bracket diagonal AL With spigot With spring locking catch Aluminium		1250 AL	4212002	7.8
Bracket Without spigot With spring locking catch Ø 48 mm		SK 230 SK 400 SK 460 SK 600	7211025 7211041 7211045 7211061	1.6 2.1 2.3 2.7
Bracket With spigot With spring locking catch Ø 48 mm		SK 564 SK 700 SK 770	7211051 7211067 7211071	5.8 5.9 6.5
Bracket diagonal To be combined with ERB 1250 or LBL 1250		SKD 1250	7212001	11.1
Scaffold tube		SR 48-1000 SR 48-1500 SR 48-2000 SR 48-2500 SR 48-3000 SR 48-3500 SR 48-4000 SR 48-4500 SR 48-5000 SR 48-6000	7241100 7241150 7241200 7241250 7241300 7241350 7241400 7241450 7241500 7241600	4.1 6.1 8.0 10.3 12.4 14.1 16.7 18.0 20.1 24.1
Right angle coupler Jaw width 22 mm		KF 48x48 22 mm	2048010	1.2
Swivel coupler Jaw width 22 mm		KV 48x48 22 mm	2048011	1.4

Suspension devices

Name		Code	Item No.	Weight
Suspension device chain Construction height 1362 and 850 mm Safe working load 20.0 kN		Susp. device chain 1362	7175001	4.3
		Susp. device chain 850	7175002	3.0
Clamp H-beam For H-beam with flange width 80-180 mm, 150-300 mm or 300-450 mm Safe working load 20.0 kN		Clamp H-beam 80-180	7172100	5.1
		Clamp H-beam 150-300	7172000	6.8
		Clamp H-beam 300-450	7172001	7.6
Clamp L-beam For L-beam with flange width 60-120 mm Safe working load 20.0 kN			7176000	5.3
Clamp bulb iron chain For bulb flats 220x10-300x13 Safe working load 20.0 kN *Load decreases depending on angle of the suspension chain			7177001	2.5
Clamp bulb iron chain For bulb flats 160x9-200x12 Safe working load 20.0 kN *Load decreases depending on angle of the suspension chain			7177002	2.5
Clamp bulb iron chain For bulb flats 320x11.5-370x16 mm Safe working load 20.0 kN *Load decreases depending on angle of the suspension chain			7177003	3.7
Suspension device Clamp Bulb Iron Chain For bulb flats 160x8 mm Safe working load 12.0 kN			7177000	1.6

Name	Code	Item No.	Weight
<p>Clamp bulb iron tube For bulb flats 160x8 Jaw width 22 mm Safe working load 20.0 kN</p>		7177100	3.0
<p>Suspension device grating Safe working load 20.0 kN</p>		7171001	2.4
<p>Suspension device double 20 mm diameter hole Safe working load 20.0 kN *Maximum load decreases depending on which standard the suspension device is attached to and the angle of the chain.</p>		7175101	2.1
<p>Clamping device 500 Jaw width 30 mm Fitted to edge of plate of thickness 15-35 mm</p>		7215032	5.5
<p>Chain Chain with long links of type LLU-11-8 Safe working load 20.0 kN</p>	LLU-11-8	6150506	2.1
<p>Shackle Safe working load 20.0 kN</p>	SA-10-8	6130251	0.4

For other accessories, see HAKI Component List.

Information on safety when erecting and dismantling

1. Carry out local risk assessment and method statement.
2. Make sure that all lifting equipment to be used, e.g chain hoists, lifting ropes, pulley blocks, etc., has been thoroughly tested and approved by an authorised person in accordance with local regulations.
3. Check that tools and protective equipment are available at the worksite.
4. Wear appropriate personal safety equipment at all times, e.g. safety harnesses, proper independence lifelines with suitable fixings, etc.
5. When erecting and dismantling a scaffold, robust temporary decking must be used as temporary platforms for platforms for the scaffolders.
6. Always make sure that the safety locking devices that prevent a platform lifting off have been activated once a platform has been installed.
7. Study all relevant instructions or safety directions from the manufacturers of the various scaffolds that are to be used.
8. Never climb up a scaffold from the outside. Always use the stairs, ladders or climbing frames that are designed to provide access to the upper decks from the inside of the scaffold.
9. If the scaffold is to be used outdoors, erection or dismantling work must be discontinued if the weather conditions are too bad. Make sure that all loose components are properly fixed before leaving the scaffold.
10. All scaffolding work must be undertaken by competent operatives under the supervision of a competent person.
11. Lifting equipment must not be attached to a free-standing scaffold.
12. Beware of any overhead power lines nearby.
13. Always observe and comply with the regulations issued by the local authorities concerned.

Instructions for dismantling

1. Dismantle the scaffold from the topmost lift.
2. Start by taking down the toe boards.
3. Take down the topmost decking.
4. Take down the horizontals and diagonals of the topmost lift.
5. Finally remove the standards where possible.
6. Repeat 2-6 to take down the second topmost lift and continue the whole process until the dismantling process reached the scaffold is completely dismantled.
7. Do not throw or drop materials to the ground. This may damage the material or cause personal injury. The materials must be lowered down to the ground by means of ropes or slings or passed down by hand.
8. If intermediate ties or tie rod tube have been installed, they must not be removed until the dismantling process reaches the level in question.
9. Always observe and comply with the regulations published by the local authorities concerned.
10. Reference should also be made to the section "Information on safety when erecting and dismantling" in this manual.

A yellow triangular warning icon with a black exclamation mark inside.

NOTE! Important information!

All the mentioned suspension devices from HAKI may only be used for suspension of scaffolding material.

All use of these products for lifting gear or similar use is strictly prohibited.
HAKI's product liability only applies if the products are properly used for scaffolding.
If in doubt contact HAKI Technical Support.

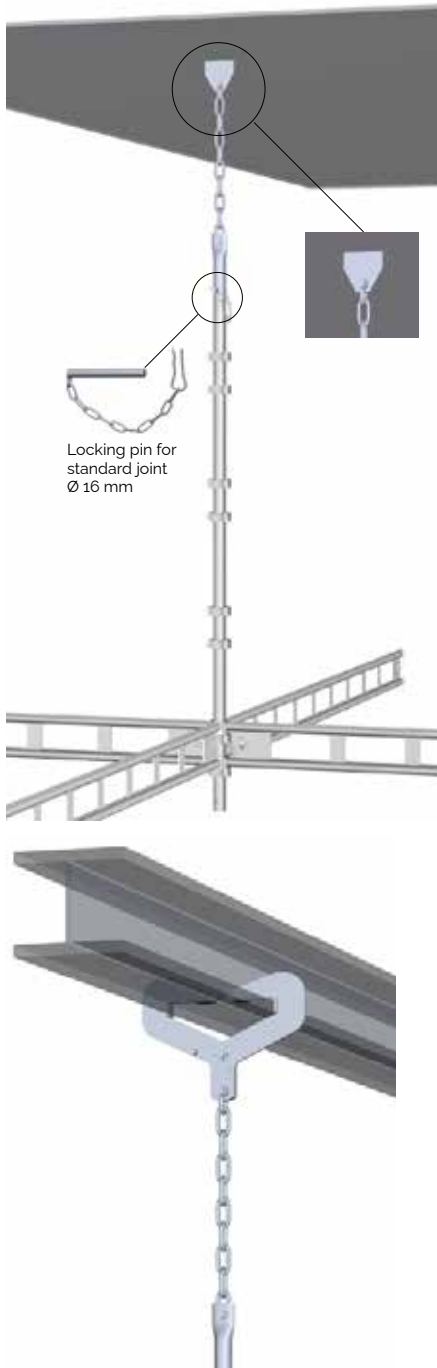

Item no.7175001/7175002

Suspension device chain

Available in two versions with construction heights 1362 and 850 mm.

The device can be adjusted in height in 64 mm stages by moving the shackle in the chain.

Used for suspending a standard in another suspension device or in a welding lug or similar.

Welding lugs or similar must be capable of bearing a load of 40 kN and be suitable for shackle 6130251.

Permissible load 20.0 kN.

PLEASE NOTE: The permissible load is much reduced when the chain is at an angle to the standard and with increased distance to the first beam node.

When the acute angle between the chain and the standard is large and when fixing further down the standard, use KF 48 double suspension device 7175101 in combination with chain and shackle.



Item no.7172000/7172100

Clamp H-beam 80-180

Designed for H-beam with flange width 80-180 mm, flange thickness max 35 mm and thickness of web max 16 mm.

Clamp H-beam 150-300

Designed for H-beam with flange width 150-300 mm, flange thickness max 35 mm and thickness of web max 20 mm.

Used in combination with chain suspension device 7175001 or 7175002.

Permissible load 20.0 kN.



Item no. 7172001



Clamp H-beam 300-450

Designed for H-beam with flange width 300-450 mm, flange thickness max 45 mm and thickness of web max 40 mm.

Used in combination with chain suspension device 7175001 or 7175002.

Permissible load 20.0 kN.

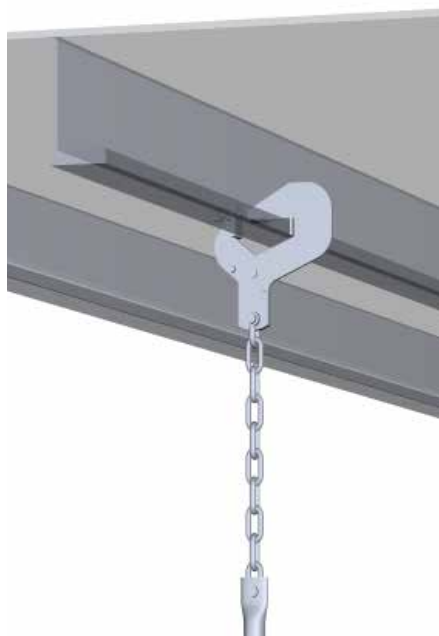

Item no. 7176000



Clamp L-beam 60-120

Designed for L-beam with flange width 60-120 mm, flange thickness max 35 mm and thickness of web max 15 mm.

Used in combination with chain suspension device 7175001 or 7175002.

Permissible load 20.0 kN.

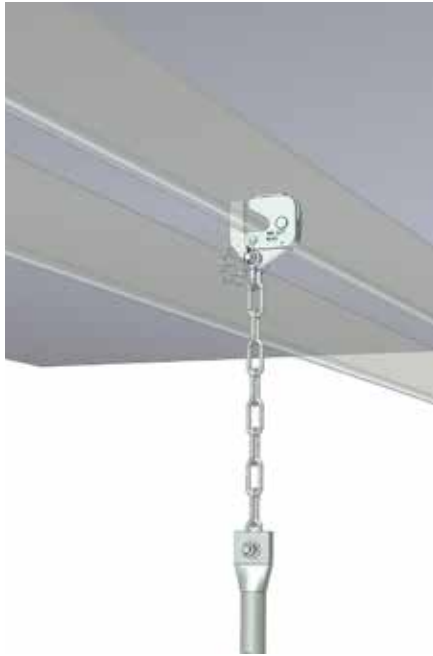

Item no. 7177001/7177002/7177003



Clamp bulb iron chain 160x9-200x12

Designed for bulb flats (Holland profile)
160x11-220x12 mm.

Clamp bulb iron chain 220x10-300x13

Designed for bulb flats (Holland profile)
220x10-300x13 mm.

Clamp bulb iron chain 320x11,5-370x16

Designed for bulb flats (Holland profile)
320x11,5-370x16 mm.

Used in combination with chain suspen-
sion device 7175001 or 7175002.

Permissible load 20.0 kN.

*Load decreases depending on angle of
the suspension chain.

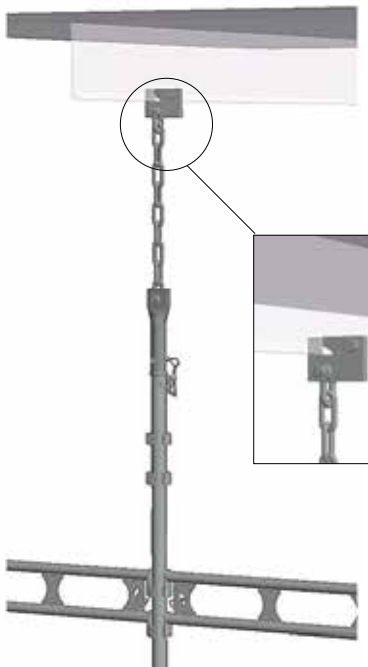

Item no. 7177000



Suspension Clamp Bulb Iron Chain

Designed for bulb flats 160x8 mm.

Used in combination with chain suspen-
sion device 7175001 or 7175002.

Permissible load 12.0 kN.

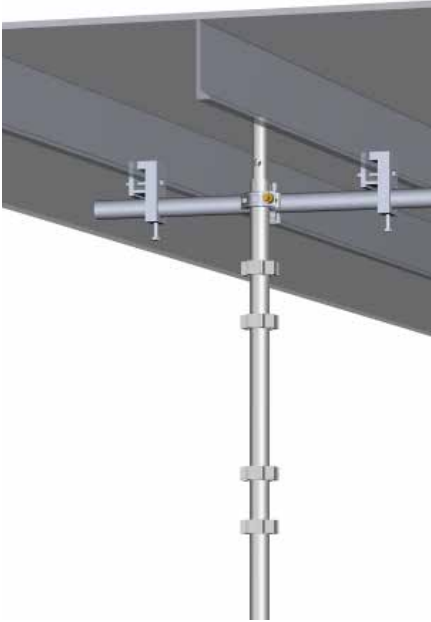

Art. nr 7177100



Clamp bulb iron tube

Designed for bulb flats (Holland profile) 160x8 mm.

Used in combination with scaffold tubes and right angle couplers.

Permissible load for device 20.0 kN. However, scaffold tubes and couplers limit the permissible load in the standard.

The device may be modified for other profile sizes.



Item no. 7171001



Suspension device grating

Designed for gratings with minimum opening 42x16 mm and up to 80x80 mm. Can also be used in holes of at least \varnothing 45 mm.

Used in combination with chain suspension device 7175001 or 7175002.

Permissible load 20.0 kN.

Item no. 7175101



Suspension device KF 48 double

Used for suspension of a standard in a welding lug or similar when the chain suspension device 7175001/7175002 cannot be used. For example, when the acute angle between the chain and the standard is large and when fixing further down the standard and also when the top of the standard is occupied by another standard.

The Suspension device must always be mounted directly below a group of pockets to avoid sliding.

Used in combination with chain with long links of type LLU-11-8 and shackle 6130251.

Permissible load 20.0 kN.

PLEASE NOTE: The permissible load is much reduced when the chain is at an angle to the standard and with increased distance to the first beam node. See pages 25-28 for more information regarding angular changes and permissible loads.

Recommended tightening torque 60 Nm, maximum tightening torque 80 Nm.

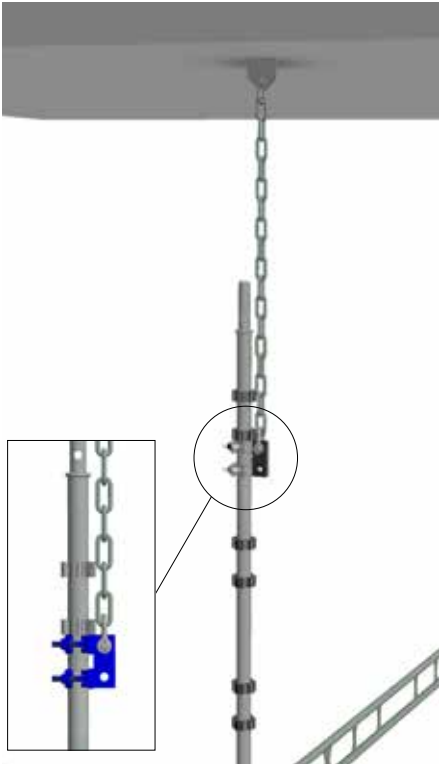

Item no. 7215032

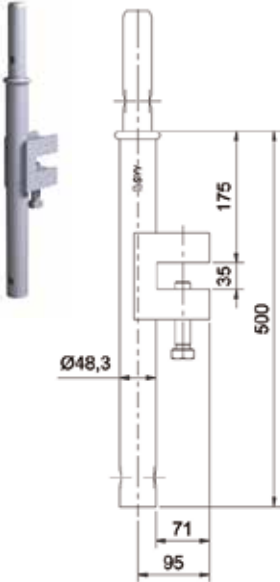

Clamping device 500

Use:

Used to fix to edges of plate thickness 15 – 35 mm.

Technical information:

The permissible vertical load is +/- 20.0 kN.

The tightening torque is 34 Nm for an oiled screw and 45 Nm for a dry screw.

Control & Maintenance

The clamping device shall be checked as part of the regular scaffold inspection.

The clamping device shall be stored dry and checked for errors and damages regularly, especially before and after erection.

Damaged fittings shall be discarded immediately.

Clamping device 500: Attached to plate edge



The clamping device shall only be used in environments where there is no vibration.

The strength of the plate/edges must be assessed. If needed, the plate shall be secured before the clamping bracket is mounted.

The clamping device shall be erected perpendicular to the plate.

It is very important that the plate edge is evenly thick so that the clamping device gets a good abutment surface.



Clamping device 500: Attached to standing and suspended scaffold

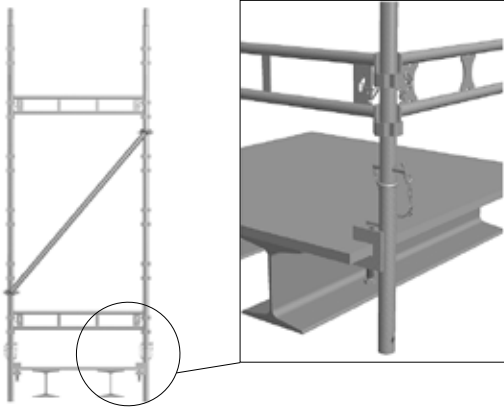

The clamping device shall be used to hold erected and suspended scaffold upright, as shown in the pictures.

The fittings shall be erected in pairs to avoid torques.

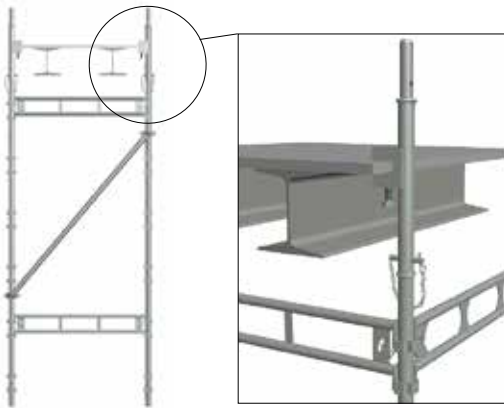

Clamping device 500: Attached with guardrail frames

Max 70 kg



Clamping devices in combination with standards and beams or guardrail frames are designed for use as edge guards in accordance with EN 13374 Class A and the scaffolding standard EN 12811-1.

Clamping device 500: Safety against torque or torsion



The clamping device shall be erected and loaded so that torques are avoided.

All Loads acting on attachments must be verified to avoid overloading.

HAKI recommends that the devices be erected in pairs or attached to adjacent construction for increased security.

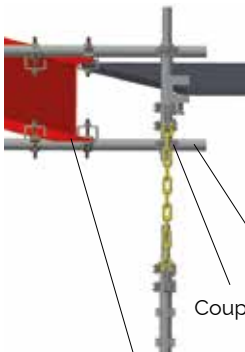

I-beam with coupler

Tube
Coupler

Standard joints

In order to be capable of bearing tensile loads, the standard joints of the suspended scaffolding must be locked using 16 mm locking pins.

Bracing and anchoring

All suspended scaffold structures must be vertically braced or anchored in all directions and be braced horizontally in order to be capable of withstanding any lateral forces from, for example, wind load. The nodes between horizontal and vertical elements may otherwise be damaged and in the worst case fail.

Inverted beam

The unique design of the HAKI Universal system, in which the attachment of horizontal to vertical elements is symmetrical, allows a beam installed upside-down in a pair of standards to carry a scaffolding structure. In this case, the permissible load on a standard depends on the beam used and the position and distribution of the support. A narrow support is equivalent to a point load on the beam; and the attachment of the beam to the standard is the principal determining factor where a support is the full length of the beam.



HAKI Suspension Devices

HAKI suspension devices make it possible to suspend scaffolding from virtually any load-bearing structure.

HAKI's many years of experience of scaffolding construction in the offshore and shipbuilding industry have resulted in a unique range of suspension devices.

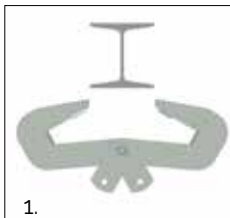

Open the device and suspend it from the beam.

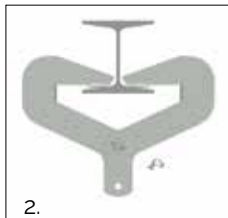

The 4.5 mm hole is designed to be used when temporarily locking the device during installation. A locking pin, awl or similar in the hole locks the device provisionally ...



... until the shackle in the suspension device chain has been fitted in the suspension hole and locks the device permanently.

Permissible loads on aluminium standards

In suspended scaffolding, standard joints must be locked using 16 mm locking pins. The permissible tensile load in suspended scaffolding is 20.0 kN.

This applies to both steel and aluminium standards.

PLEASE NOTE: The permissible load is much reduced when the chain is at an angle to the standard and with increased distance to the first beam node when using devices 7175001 and 7175002 and, in some cases, device 7175101 too. Please contact HAKI's technical department for information.

Permissible loads on aluminium beams

Permissible loads on beams installed in HAKI standards.

Beam type	Permissible load	Permissible distributed load	Permissible centrepoint loads	Permissible point loads	Permissible point loads	Permissible point loads
	q [kN/m]	Q [kN]	P [kN]	P ₂ [kN]	P ₃ [kN]	P ₄ [kN]
LB 1655 AL	16.8	27.0	13.5	6.8	10.1	13.5
LB 1964 AL	11.8	22.6	11.3	5.7	8.5	11.3
LB 2500 AL	7.2	17.6	8.8	4.4	6.6	8.8
LB 3050 AL	4.8	14.4	7.2	3.6	5.4	7.2
ERB 700 AL	26.2	17.0	8.5	4.3	6.4	8.5
ERB 770 AL	23.6	17.0	8.5	4.3	6.4	8.5
ERB 1050 AL	17.0	17.0	8.5	4.3	6.4	8.5
ERB 1250 AL	11.8	14.2	7.1	3.6	5.3	7.1
ERB 1655 AL	5.6	9.0	4.5	2.2	3.4	4.5
ERB 1964 AL	3.8	7.3	3.7	1.8	2.8	3.7
ERB 2500 AL	2.4	6.0	3.0	1.5	2.3	3.0
ERB 3050 AL	1.6	4.7	2.4	1.2	1.8	2.4

Permissible loads on steel standards







In suspended scaffolding, standard joints must be locked using 16 mm locking pins. The permissible tensile load in suspended scaffolding is 20.0 kN.

This applies to both steel and aluminium standards.

PLEASE NOTE: The permissible load is much reduced when the chain is at an angle to the standard and with increased distance to the first beam node when using devices 7175001 and 7175002 and, in some cases, device 7175101 too. Please contact HAKI's technical department for information.

Permissible loads on steel beams

Permissible loads on beams installed in HAKI standards.

Installed normally						
Installed upside down						
Beam type	Permissible load q [kN/m]	Permissible distributed load Q [kN]	Permissible centrepoint loads P [kN]	Permissible point loads P ₂ [kN]	Permissible point loads P ₃ [kN]	Permissible point loads P ₄ [kN]
LBL 1050	32.4	34.0	11.0	5.5	11.0	12.4
LBL 1250	21.4	26.7	9.5	4.8	8.5	10.0
LBL 1655	15.1	25.0	9.2	4.6	7.7	10.1
LBL 1964	11.3	22.2	6.9	3.5	6.7	10.0
LBL 2500	7.9	19.8	7.0	3.5	7.1	8.0
LBL 3050	5.2	15.7	5.8	2.9	5.7	7.2
LB 3650	2.4	8.6	4.3	2.2	3.2	4.3
LB 4050	2.4	9.6	4.8	2.4	3.6	4.8
ERB 700	39.3	26.0	13.0	6.5	9.8	13.0
ERB 770	38.5	26.0	13.0	6.5	9.8	13.0
ERB 1050	25.4	26.0	13.0	6.5	9.8	13.0
ERB 1250	21.7	26.0	13.0	6.5	9.8	13.0
ERB 1655	12.4	19.9	10.0	5.0	7.5	10.0
ERB 1964	6.8	13.0	6.5	3.3	4.9	6.5
ERB 2500	3.8	9.3	4.7	2.3	3.5	4.7
ERB 3050	3.0	9.0	4.5	2.2	3.4	4.5

Permissible load classes for different aluminium beam combinations

The tables apply to HAKI Universal Aluminium LB AL or ERB AL beams for varying bay sizes, decking of weight 16.5 kg/m² and unilateral or bilateral loading. In the specified load classes, no consideration has been paid to the bearing capacity of the decking.

For corresponding values for HAKI Universal in steel, please contact HAKI's technical department.

Permissible load classes for LB AL beam for unilateral loading

Ledge beam LB AL	a [m]							
	700	770	1050	1250	1655	1964	2500	3050
LB 350	6	6	6	6	6	6	6	6
LB 770	6	6	6	6	6	6	6	6
LB 1050	6	6	6	6	6	6	6	6
LB 1250	6	6	6	6	6	6	6	6
LB 1655	6	6	6	6	6	6	5	5
LB 1964	6	6	6	6	6	6	5	5
LB 2500	6	6	6	6	5	5	4	3
LB 3050	6	6	6	5	5	4	4	3

Permissible load classes for ERB AL beam for unilateral loading

Single tube beam ERB AL	a [m]								
	564	700	770	1050	1250	1655	1964	2500	3050
ERB 564	6	6	6	6	6	6	6	6	6
ERB 700	6	6	6	6	6	6	6	6	6
ERB 770	6	6	6	6	6	6	6	6	6
ERB 1050	6	6	6	6	6	6	6	6	6
ERB 1250	6	6	6	6	6	6	6	6	5
ERB 1655	6	6	6	6	6	5	5	4	4
ERB 1964	6	6	6	5	5	4	4	3	3
ERB 2500	6	5	5	4	4	3	3	3	2
ERB 3050	6	4	4	3	3	3	2	1	1

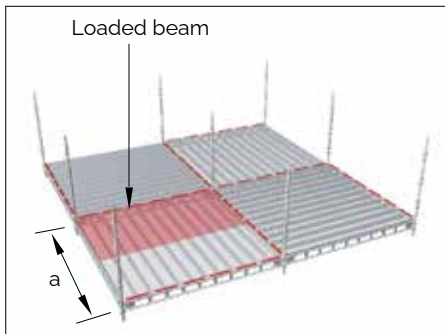

Wide scaffold

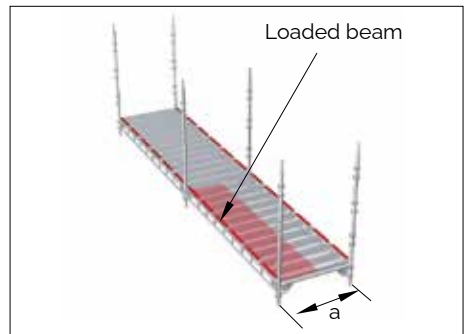

Facade scaffold

Permissible load classes for LB AL beam for bilateral loading

Ledger beam LB AL	a [m]							
	700	770	1050	1250	1655	1964	2500	3050
LB 350	6	6	6	6	6	6	6	6
LB 770	6	6	6	6	6	6	5	5
LB 1050	6	6	6	6	5	5	4	4
LB 1250	6	6	6	6	5	5	4	3
LB 1655	6	6	5	5	4	4	3	3
LB 1964	6	6	5	5	4	4	3	3
LB 2500	5	5	4	4	3	3	3	3
LB 3050	5	5	4	3	3	3	2	---

Permissible load classes for ERB AL beam for bilateral loading

Single tube beam ERB AL	a [m]								
	564	700	770	1050	1250	1655	1964	2500	3050
ERB 564	6	6	6	6	6	6	6	6	6
ERB 700	6	6	6	6	6	6	6	5	5
ERB 770	6	6	6	6	6	6	6	5	5
ERB 1050	6	6	6	6	6	5	5	4	4
ERB 1250	6	6	6	6	6	5	5	4	3
ERB 1655	6	5	5	5	4	3	3	3	2
ERB 1964	6	4	4	3	3	3	2	1	1
ERB 2500	5	4	3	3	3	2	1	1	1
ERB 3050	4	3	3	2	1	1	1	---	---

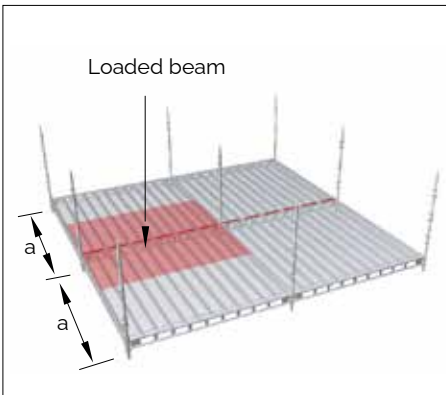

Wide scaffold

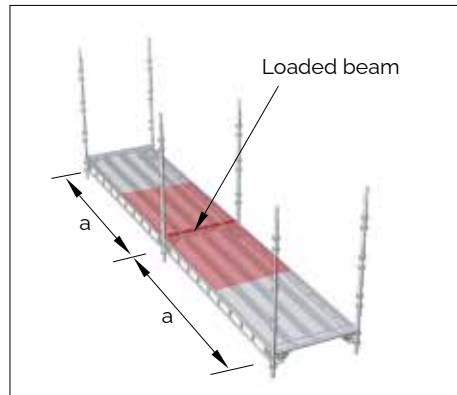

Facade scaffold

Permissible loads at angular deviation

The permissible load in the standard is greatly reduced at angular deviations and increased distance to the first beam node. This is when using devices 7175101.

Figures 1-4 show four different load cases with angular deviations. The following tables show the permissible loads on the standards and bending moments as a function of angular deviation.

Load case 1

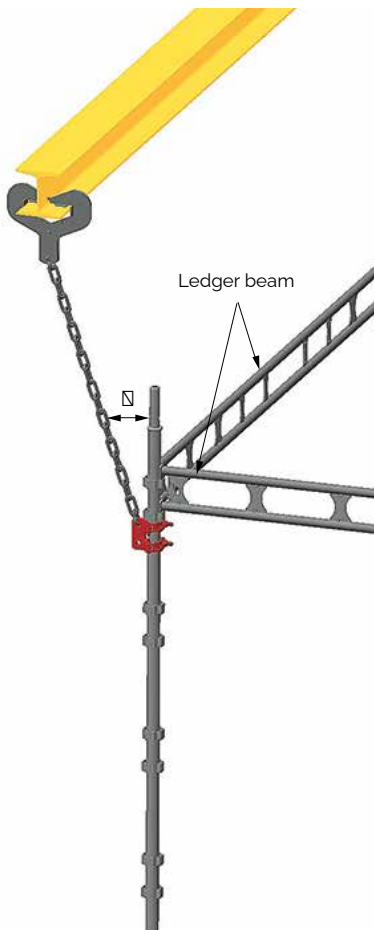

The Suspension device must always be mounted directly below a group of pockets to avoid sliding.

Load case 1: Permissible loads as a function of angular deviation

Angle α [°]	S4 AL [kN]	S6 AL [kN]	FSSH AL [kN]	S Fzv [kN]
0	11.8	16.3	5.9	15.0
5	11.2	15.5	5.6	14.2
10	10.6	14.7	5.3	13.5
15	10.1	13.9	5.1	12.9
20	9.6	13.3	4.8	12.2
25	9.1	12.6	4.6	11.6
30	8.7	12.0	4.3	11.0
35	8.2	11.3	4.1	10.5
40	7.7	10.7	3.9	9.9
45	7.3	10.0	3.6	9.3

Load case 1: Bending moment as a function of angular deviation

Angle α [°]	S4 AL [Nm]	S6 AL [Nm]	FSSH AL [Nm]	S Fzv [Nm]
0	826	1141	413	1050
5	857	1183	428	1090
10	885	1221	442	1126
15	911	1257	456	1159
20	936	1290	468	1191
25	960	1323	480	1222
30	983	1355	492	1252
35	1006	1386	503	1281
40	1030	1418	515	1312
45	1054	1450	527	1373

Permissible loads at angular deviation

Load case 2

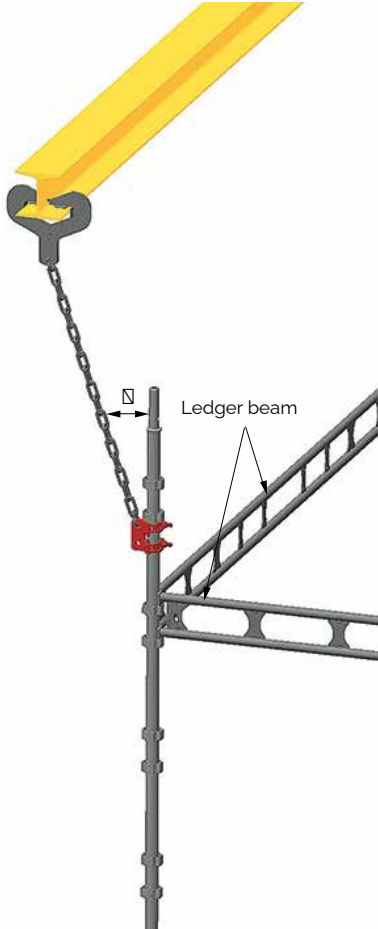

The Suspension device must always be mounted directly below a group of pockets to avoid sliding.

Load case 2: Permissible loads as a function of angular deviation

Angle Δ [°]	S4 AL [kN]	S6 AL [kN]	FSSH AL [kN]	S Fzv [kN]
0	11.8	16.3	5.9	15.0
5	13.2*	18.2*	6.6*	16.7*
10	14.9*	19.5*	7.5*	18.9*
15	17.3*	19.3*	8.6*	19.3*
20	15.2	18.6	7.6	18.6
25	9.8	13.5	4.9	12.5
30	7.1	9.7	3.5	9.0
35	5.4	7.4	2.7	6.9
40	4.3	5.9	2.1	5.5
45	3.4	4.7	1.7	4.4

Load case 2: Bending moment as a function of angular deviation

Angle Δ [°]	S4 AL [Nm]	S6 AL [Nm]	FSSH AL [Nm]	S Fzv [Nm]
0	1239	1712	620	1576
5	804*	1111*	402*	1021*
10	245*	320*	122*	311*
15	513	572	256	572
20	1187	1451	593	1451
25	1269	1751	635	1615
30	1311	1804	656	1670
35	1337	1837	668	1704
40	1354	1859	677	1727
45	1367	1875	683	1744

* In load cases 2-4, the direction of the force components leads to moments counteracting each other. This may mean that the moment on the standard is not always minimum at $\Delta = 0^\circ$

Permissible loads at angular deviation

Load case 3

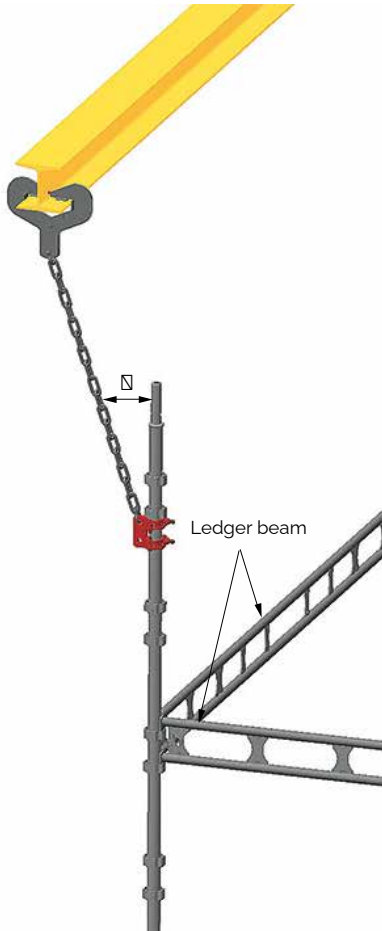

The Suspension device must always be mounted directly below a group of pockets to avoid sliding.

Load case 3: Permissible loads as a function of angular deviation

Angle α [°]	S4 AL [kN]	S6 AL [kN]	FSSH AL [kN]	S Fzv [kN]
0	11.8	16.3	5.9	15.0
5	13.2*	18.2*	6.6*	16.7*
10	10.8	14.9	5.4	13.8
15	5.8	7.9	2.9	7.4
20	3.9	5.3	1.9	4.9
25	2.9	3.9	1.4	3.7
30	2.2	3.1	1.1	2.9
35	1.8	2.5	0.9	2.3
40	1.5	2.0	0.7	1.9
45	1.2	1.7	0.6	1.6

Load case 3: Bending moment as a function of angular deviation

Angle α [°]	S4 AL [Nm]	S6 AL [Nm]	FSSH AL [Nm]	S Fzv [Nm]
0	1239	1712	620	1576
5	60*	83*	30*	77*
10	1254	1731	627	1595
15	1331	1830	666	1697
20	1360	1866	680	1735
25	1375	1886	688	1755
30	1385	1898	692	1768
35	1392	1906	696	1777
40	1397	1913	698	1783
45	1401	1918	700	1788

* In load cases 2-4, the direction of the force components leads to moments counteracting each other. This may mean that the moment on the standard is not always minimum at $\alpha = 0^\circ$

Permissible loads at angular deviation

Load case 4

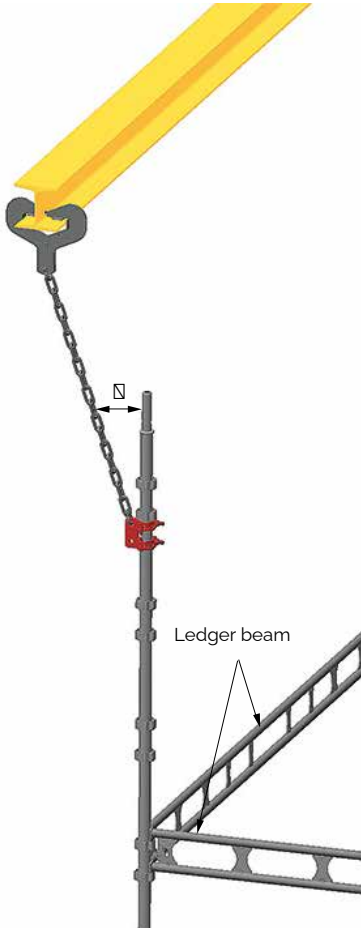

The Suspension device must always be mounted directly below a group of pockets to avoid sliding.

Load case 4: Permissible loads as a function of angular deviation

Angle α [°]	S4 AL [kN]	S6 AL [kN]	FSSH AL [kN]	S Fzv [kN]
0	11.8	16.3	5.9	15.0
5	13.2*	18.2*	6.6*	16.7*
10	5.4	7.4	2.7	6.9
15	3.2	4.4	1.6	4.1
20	2.2	3.0	1.1	2.8
25	1.7	2.3	0.8	2.1
30	1.3	1.8	0.7	1.7
35	1.1	1.5	0.5	1.4
40	0.9	1.2	0.4	1.1
45	0.7	1.0	0.4	0.9

Load case 4: Bending moment as a function of angular deviation

Angle α [°]	S4 AL [Nm]	S6 AL [Nm]	FSSH AL [Nm]	S Fzv [Nm]
0	1239	1712	620	1576
5	924*	1278*	462*	1175*
10	1337	1837	668	1704
15	1371	1880	685	1749
20	1385	1898	693	1768
25	1394	1909	697	1779
30	1399	1916	699	1786
35	1403	1920	701	1791
40	1406	1924	703	1795
45	1408	1927	704	1798

* In load cases 2-4, the direction of the force components leads to moments counteracting each other. This may mean that the moment on the standard is not always minimum at $\alpha = 0^\circ$

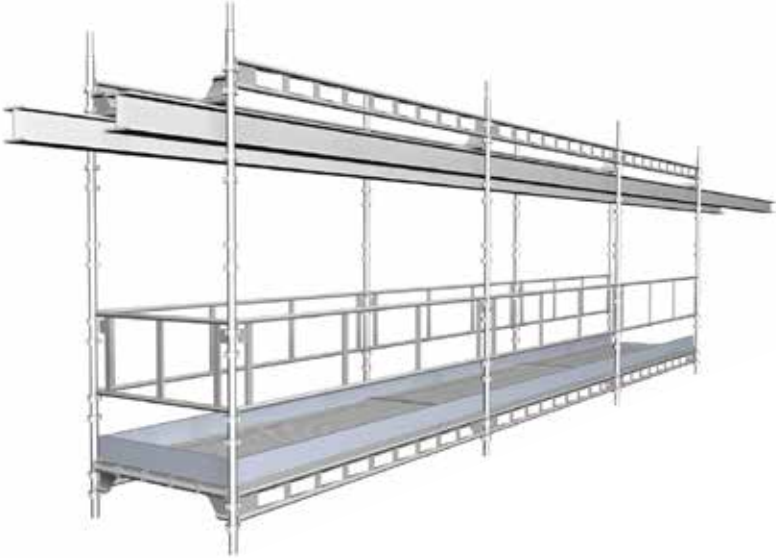

Example of section of scaffolding suspended from inverted beam.



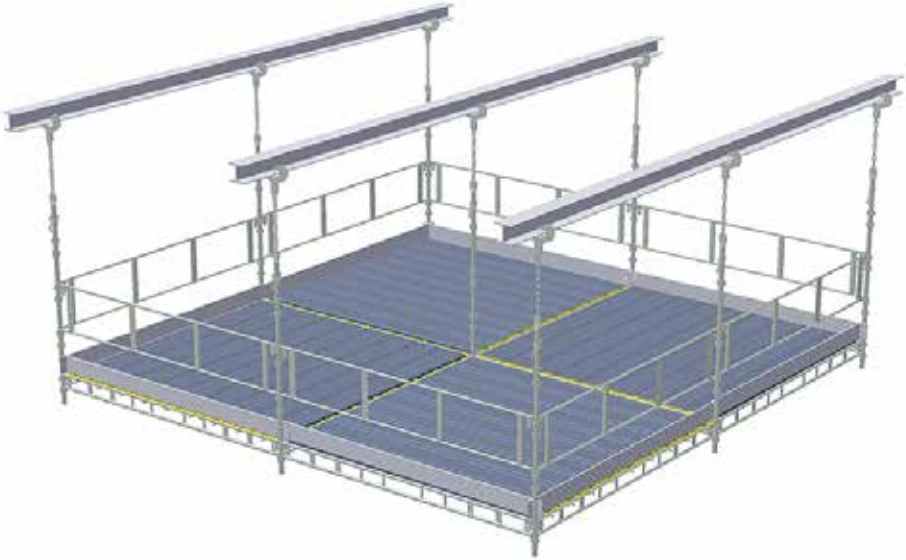

Example of section of scaffolding suspended from suspension devices.

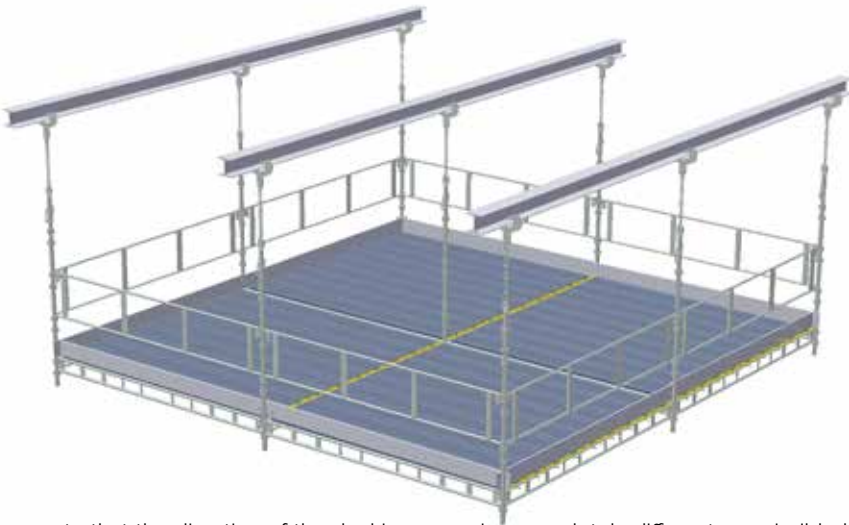

Please note that the direction of the decking may give completely different permissible loads on the lift.

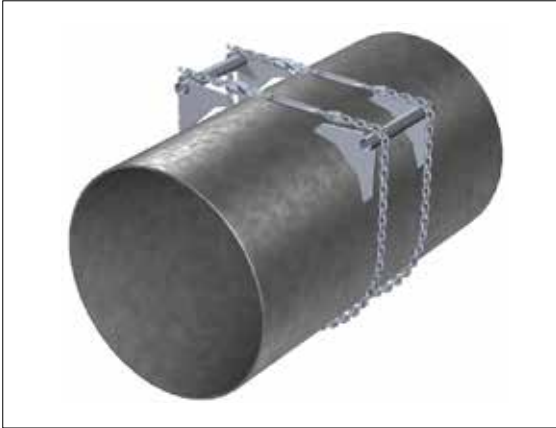

Friction trestle

Used to fix a scaffolding section to a round structure of diameter approximately 600 – 2600 mm.

Two trestles are used for a horizontal structure and four for a vertical structure.

Beams, standards or scaffold tubes are attached using KF 48x48 right-angle couplers to the tubes of the trestle, which are 48 mm in diameter and 190 mm long.

PLEASE NOTE: The turnbuckles must be secured against turning.

Please contact HAKI's technical department for permissible loads.

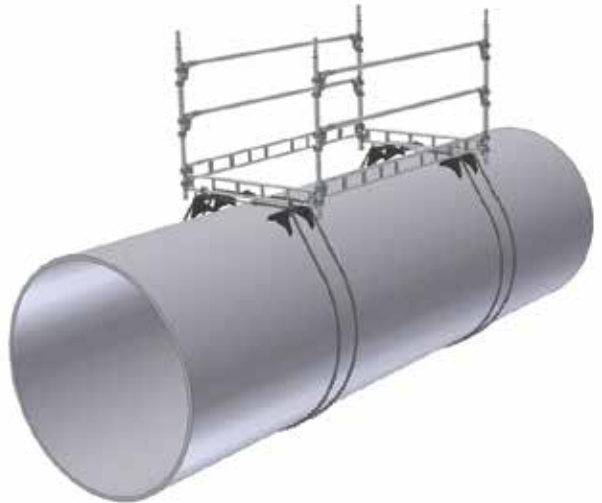

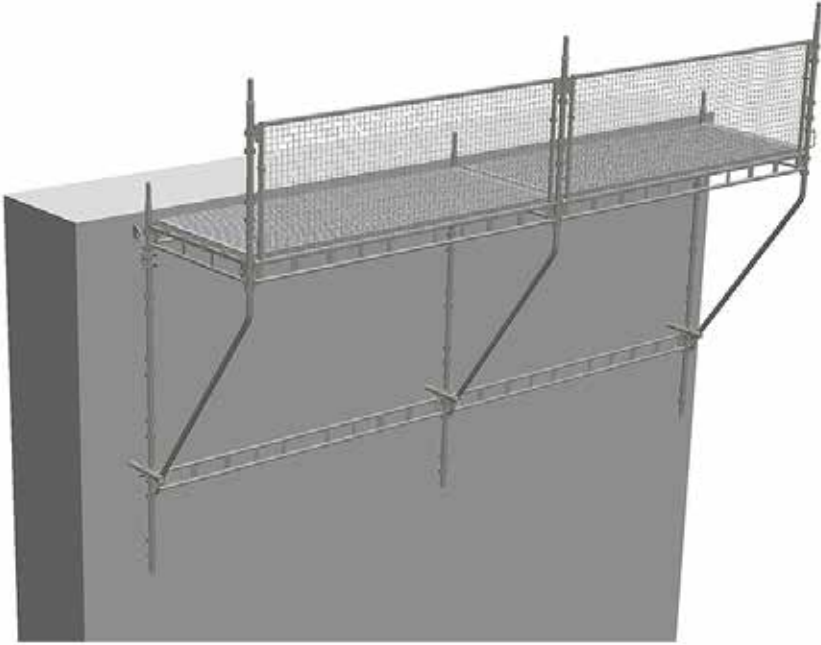

Example of suspended scaffolding with brackets.



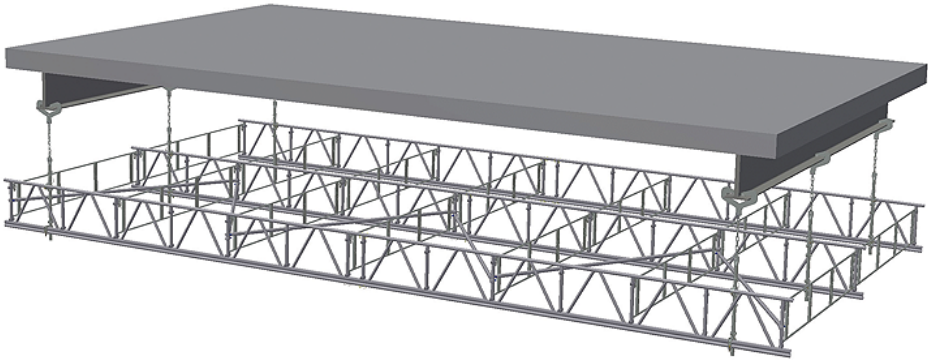

Example of wide suspended scaffolding with 750 AL lattice beams.

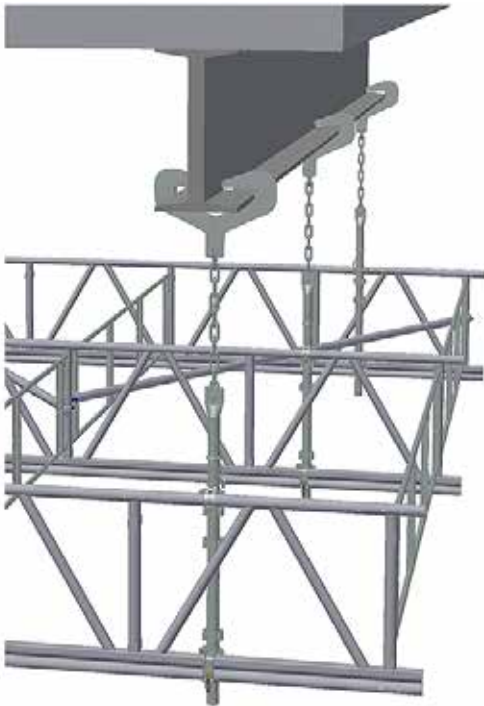

Maintenance & storage

1. After use, all components must be thoroughly cleaned and inspected before storage.
2. Any damaged parts or components found must be replaced.
3. The manufacturer or supplier must be consulted before repairing scaffold material.
4. Components must be sorted and stacked properly. Take care not to pile the stacks too high, so that the material lower down in the stacks becomes overloaded and damaged. If the material must be stacked up high, suitable racking and shelves should be used.
5. Wooden and plastic components (e.g. platforms, toe boards, toe board holders, etc.) should be stored in a sheltered area so as to maximize their working life.

Wind, ice and snow

Since extreme weather conditions may occur during winter months, it is important to remove snow and ice immediately.

As regards wind loads for clad scaffolding, calculations should be made in each individual case.

Attachment points for personal fall protection equipment

Permissible points of attachment for personal fall protection equipment are as described below.

PLEASE NOTE: Recommendations for points of attachment apply provided that the component in question is otherwise without load and that only one person is attached to the same component at any one time.

Components that have been subjected to loading from fall protection equipment must be scrapped and replaced by new material.

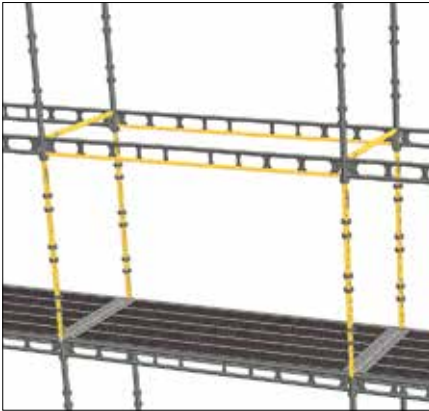

Around a standard between two lifts or around the lower tube of an LBL or LB ledger, G or AL, fitted between two standards.

Attachment around the tube of an ERB single tube beam is permitted only for Universal beams of hot-dip galvanized steel of maximum size ERB 2050 G fitted between two standards.

PLEASE NOTE: Attachment around a Universal AL beam of type ERB single tube beam is not permitted.



Around a free standard, but only within 40 cm of the node.

PLEASE NOTE: Not next to a standard joint.

No other points of attachment can be recommended. Fall protection equipment **MUST NOT** be attached to guardrails, brackets and cantilevers, i.e. beams fixed at only one end.

Fall protection equipment **MUST NOT** be attached to components that have not been locked into place.

PLEASE NOTE: Use only approved safety equipment.



SAFETY CHECKLIST

1. Supporting surface checked with regard to load-bearing capacity
2. Distance to wall or similar as short as possible
3. Scaffold aligned correctly horizontally and vertically
4. Components correctly fitted and locked
5. Bracing correctly fitted
6. Anchoring with right number and placing of ties
7. Decking correctly fitted
8. Guardrail with toeboard if drop is two metres or more
9. Suitable means of access to scaffold
10. Scaffold erected for correct class of load

