

TD N122-070 (en)

Part No.: N122-070
 Name: NS Balcony Attachment
 Weight: 1.1 kg
 Standard: EN 13374-A
 Material: Galvanised Steel
 Dimensions: mm



This Technical Document must always be used in conjunction with **HAKI's General Qualifications** -See below

1. Always plan your work and installation
2. Always select the right equipment
3. Always regularly inspect your system

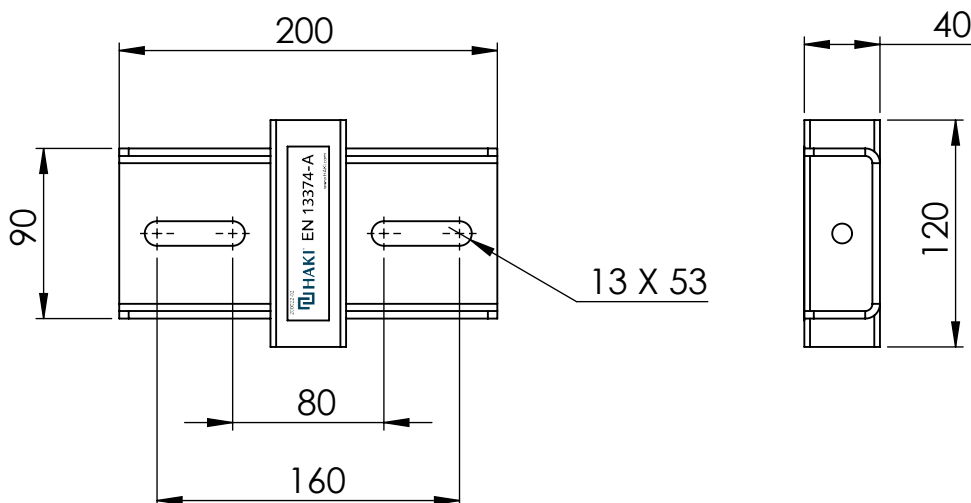
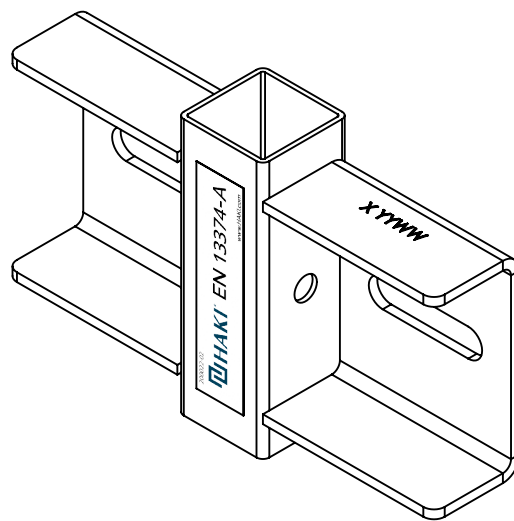

www.HAKI.com

1.

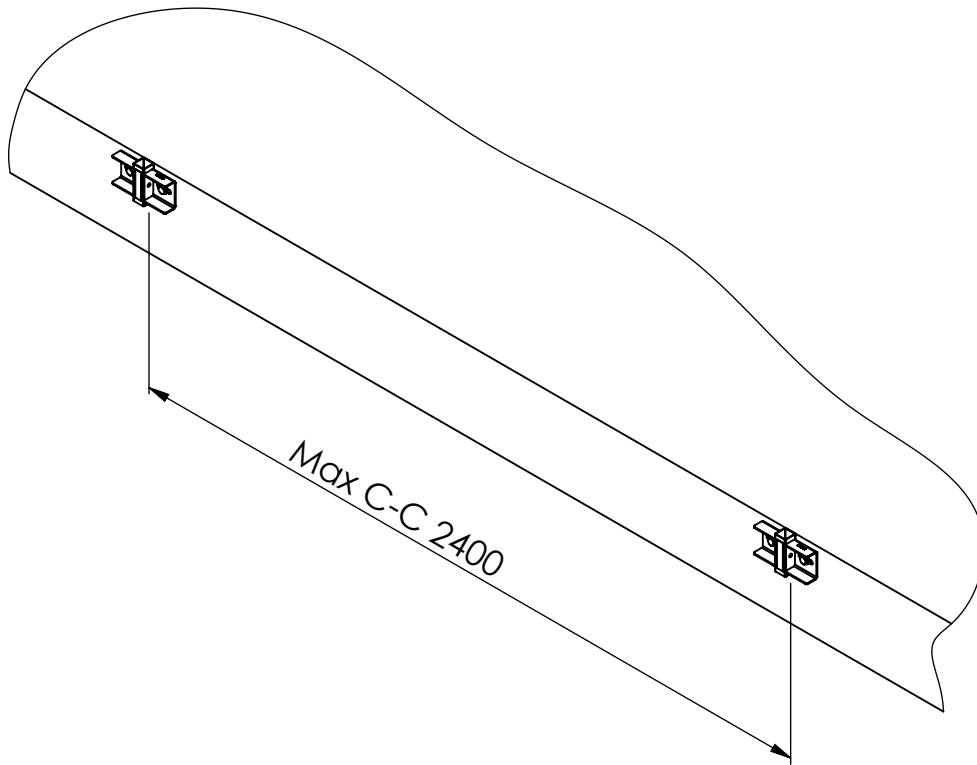

2.

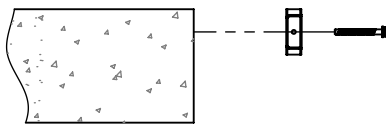
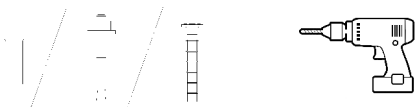

3.

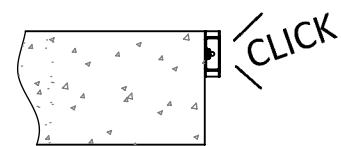
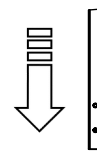

4.

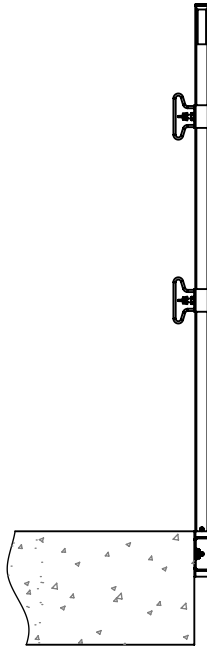

5.

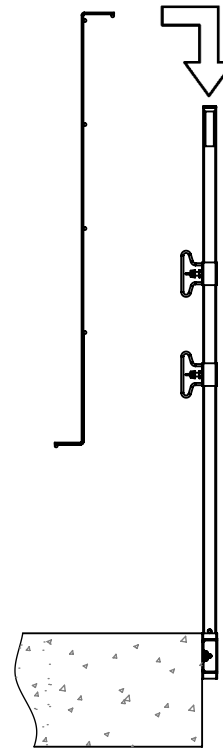

6.

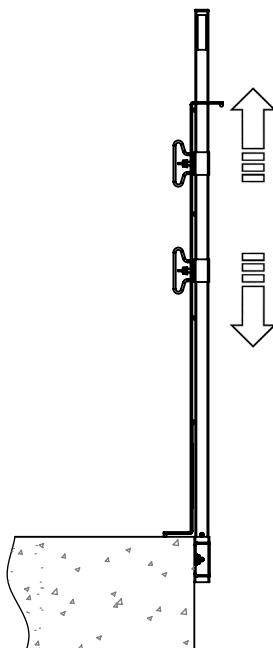

7.

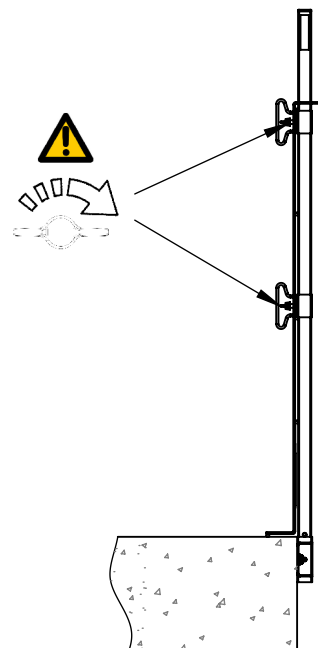

TD N122-070 (en)

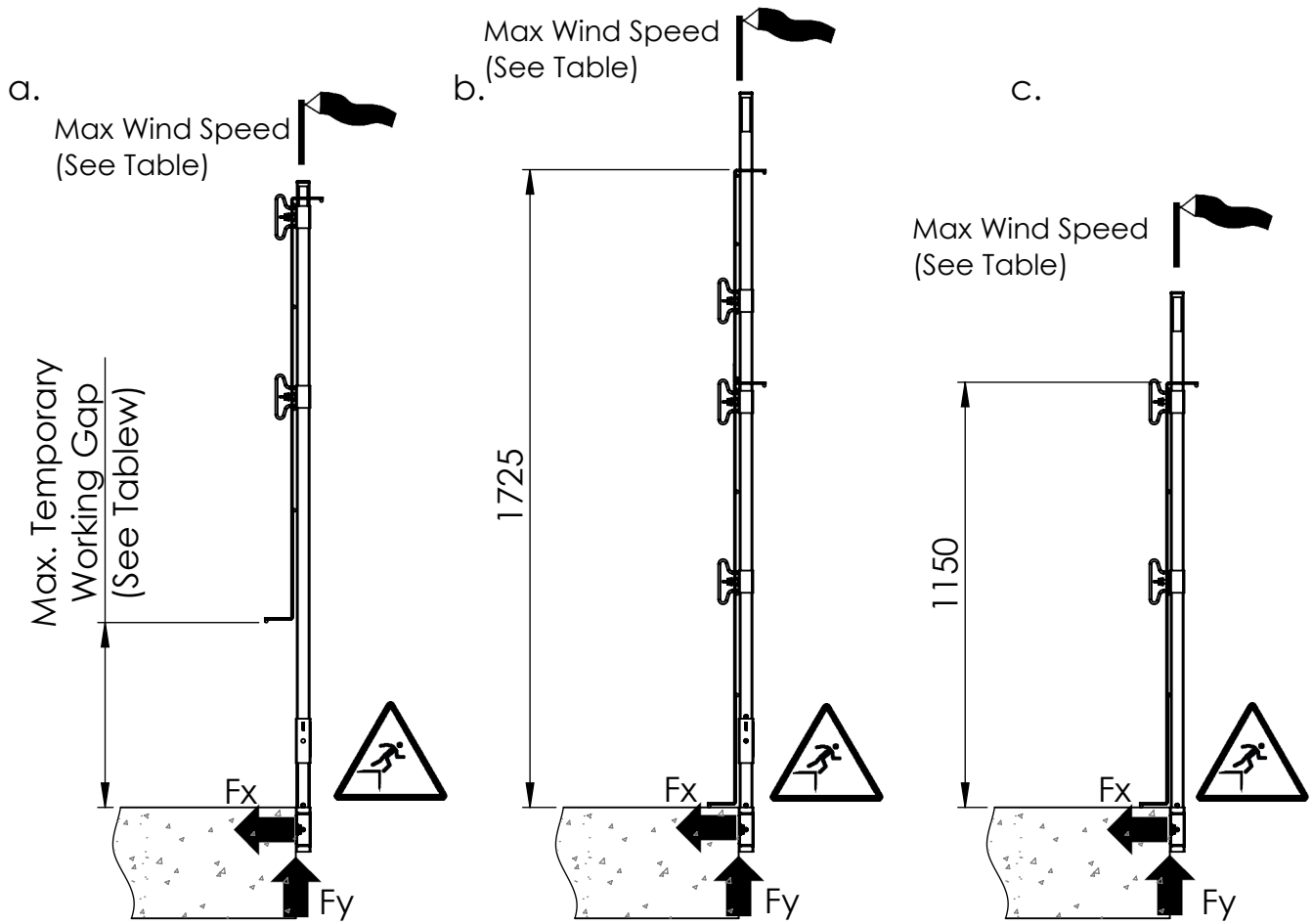

See Table for F_y & F_x values

*Dimensions relate to V Barrier Mk2 90 2600

Barrier Configuration:

8. (Applicable for both all VS & NS Posts)

| a. (Standard Barrier in raised position) | | | | | |
|--|---------------|------------------------|-----------------------|--------------------------------|-----------------------------|
| Barrier | Post C-C [mm] | Raised height (T) [mm] | Max. wind speed [m/s] | Pull out Load (F_x^*) [kN] | Shear Load (F_y^*) [kN] |
| MK2-90 | ≤ 2400 | 364.5 | 32 | 10.0 | 0.8 |
| MK4 | | 220 | | | |
| MK5 | | 441.5 | | | |
| MK6 | | 500 | | | 0.75 |

*Load calculation per fixing

| b. (Standard Barrier + Make-up Barrier) | | | | | |
|---|-----------------|---------------|-----------------------|--------------------------|-----------------------|
| Barrier | Make-up Barrier | Post C-C [mm] | Max. wind speed [m/s] | Pull out Load (Fx*) [kN] | Shear Load (Fy*) [kN] |
| MK2-90 | MK2-90/MK5 | ≤ 2400 | 32 | 7.9 | 0.9 |
| MK4 | MK4 | | N/A | | |
| MK5 | MK5 | | 32 | 7.15 | 0.85 |
| MK6 | MK6 | | | 6.55 | 0.82 |

*Load calculation per fixing

| c. (Standard Barrier) | | | | |
|-----------------------|---------------|-----------------------|--------------------------|-----------------------|
| Barrier | Post C-C [mm] | Max. wind speed [m/s] | Pull out Load (Fx*) [kN] | Shear Load (Fy*) [kN] |
| MK2-90 | ≤ 2400 | 36.5 | 5.75 | 0.8 |
| MK4 | | 32.9 | 6.75 | |
| MK5 | | 38.1 | 5.75 | |
| MK6 | | 42.0 | 5.3 | 0.75 |

*Load calculation per fixing

Note:
N/A - Not Applicable

General Qualifications



These General Qualifications are applicable to all HAKI products and must always be read in conjunction with each products Technical Documentation (TD).









General



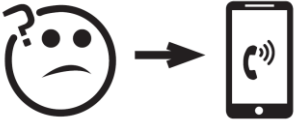





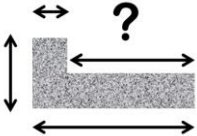

- Always check general product condition before use
- If in doubt always ask by contacting a representative of HAKI
- Reject any damaged or rusty components
- HAKI products and systems provide temporary protection during construction activity.
- HAKI products are NOT tested or intended:
 - to withstand impact by any vehicle,
 - to support or provide control of the public,
 - for the containment of bulk materials.

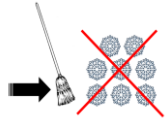

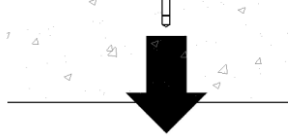

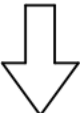

Always Plan your works

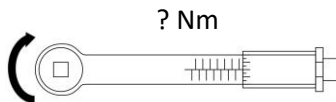
- Take note of location, proximity to permanent and temporary hazard structures.
- Take note of dimensions, layout and access areas.
- Always identify both the fall hazard for the installer and the falling materials hazard for persons and property below.
- These identified hazards should also be considered on dismantling.
- HAKI strongly recommends seeking competent Work at Height advice if in any doubt about the installer's or other's safety.
- Note the component weight as given on the TD sheets and ensure suitable handling equipment is available.
- Ensure local site Risk Assessment / Method Statement detail is observed and followed.

| |
|--|
| <p>Fixing selection</p> <ul style="list-style-type: none"> • All fixings should be confirmed as suitable for the chosen application site. • Material type and thickness, edge proximity, depth of embedment, and proximity to other fixings, all impact the strength of a fixing. Please refer to manufacturer's instructions for fixing guidance and limitation. • The dimensions for installation and the load capacity should be confirmed by the fixing manufacturer for each application. • Competent fixings advice should be sought if in any doubt. |
| <p>Fine mesh containment</p> <ul style="list-style-type: none"> • Note that the addition of any fine containment mesh (such as on barriers or safety nets) increases the wind load attracted to the supports. • Technical advice must be sought before any such addition. |
| <p>Weather</p> <ul style="list-style-type: none"> • HAKI products and systems can be adversely impacted by significant wind speeds. Please note limitations on product TD and take any recommended remedial action. If in doubt, contact a HAKI representative. • If in doubt, cease work, and use additional protection measures as required. • All safety systems should be kept clear of ice and snow. |
| <p>Inspection</p> <ul style="list-style-type: none"> • All installed systems should be checked at least once every 7 days by a competent person, to ensure its continued integrity and that there are no signs of any potential failing. • We recommend that these checks are recorded in a site log. • Please ensure any defective product identified during inspection is replaced immediately. |
| <p>Loading</p> <ul style="list-style-type: none"> • Any HAKI products subjected to loading, or used in anger, should be assessed to ensure it continues to provide the necessary protection. If this involves removing from service you must ensure the area is otherwise protected. • The system should then be fully inspected, any components replaced as necessary, and the installation confirmed as fit for continued use by a competent person. |
| <p>Storage</p> <ul style="list-style-type: none"> • HAKI recommends the use of its own storage and transit solutions. • Take careful note of lifting and loading limits. • All components should be stored in a manner that limits any detrimental environmental effect due to weather or corrosive substances. |
| <p>Traceability</p> <ul style="list-style-type: none"> • All HAKI products are traceable. |

| Key | | |
|-----|---|--|
| | Symbol | Meaning |
| 1. |  | Tech Data |
| 2. |  | If in doubt, check online @ www.HAKI.com |
| 3. |  | If in doubt call HAKI on +44 (0)1227 711072 |
| 4 |  | Always Check/ Always confirm |
| 5 |  | Fall Hazard |
| 6 |  | Do this |
| 7 |  | Don't do this |
| 8 |  | Be Aware |
| 9 |  | Recycle damaged materials |
| 10 |  | Recommended Distance |

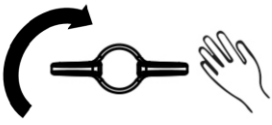
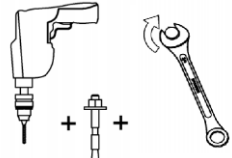
| | | |
|----|---|--|
| 11 |  | Secure yourself against falling |
| 12 |  | Protect those below from falling equipment |
| 13 |  | Catch fan – Keep Clean from snow |
| 14 |  | Shear Load |
| 15 |  | Tensile Load |
| 16 |  | Moment Load |
| 17 |  | Max Wind Load |
| 18 |  | Check Weekly |
| 19 |  | Insert |
| 20 |  | Install |
| 21 |  | Torque Spanner and settings |

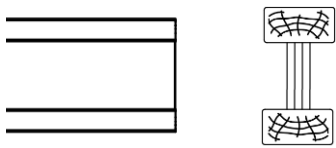
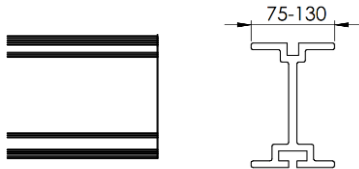
| | | |
|----|---|-------------------------------------|
| 22 |  | Flat Head Screwdriver |
| 23 |  | Cross Head/Phillips Screwdriver |
| 24 |  | Tighten |
| 25 |  | Untighten |
| 26 |  | Tighten by hand |
| 27 |  | Drill and select appropriate anchor |
| 28 |  | Floor/General |
| 29 |  | Concrete slab/floor |
| 30 |  | Timber Beam |
| 31 |  | Alu Beam |