



Escalier-passerelle 9 marches

Galvanisé à chaud

Code : N221-020
85 kg

EN 12811-1:2003
Charge ponctuelle max. : 150 kg
Charge répartie max. : 100 kg/m²

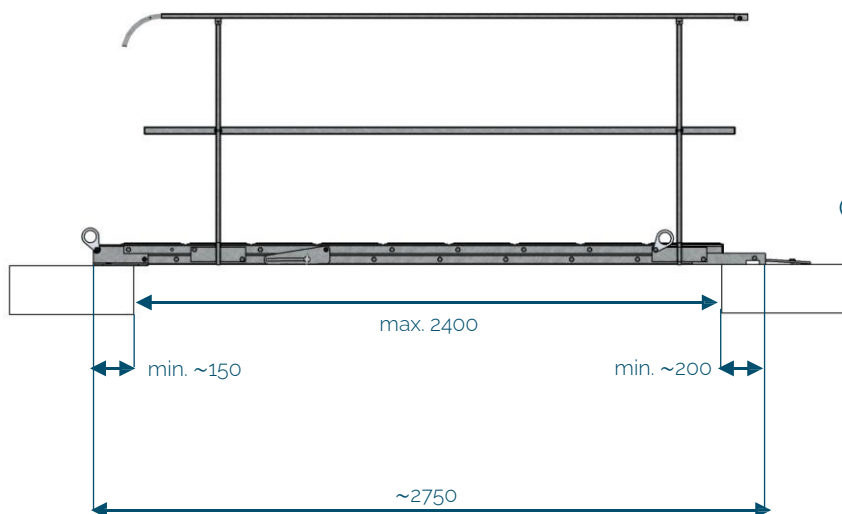

[mm]

