



Escalier 6 marches

Galvanisé à chaud

Escalier 700 mm
Code : N211-002
63 kg

Escalier 1000 mm
Code : N211-009
73 kg

EN 12811-1:2003

Charge ponctuelle max. : 150 kg
Charge répartie max. : 100 kg/m²

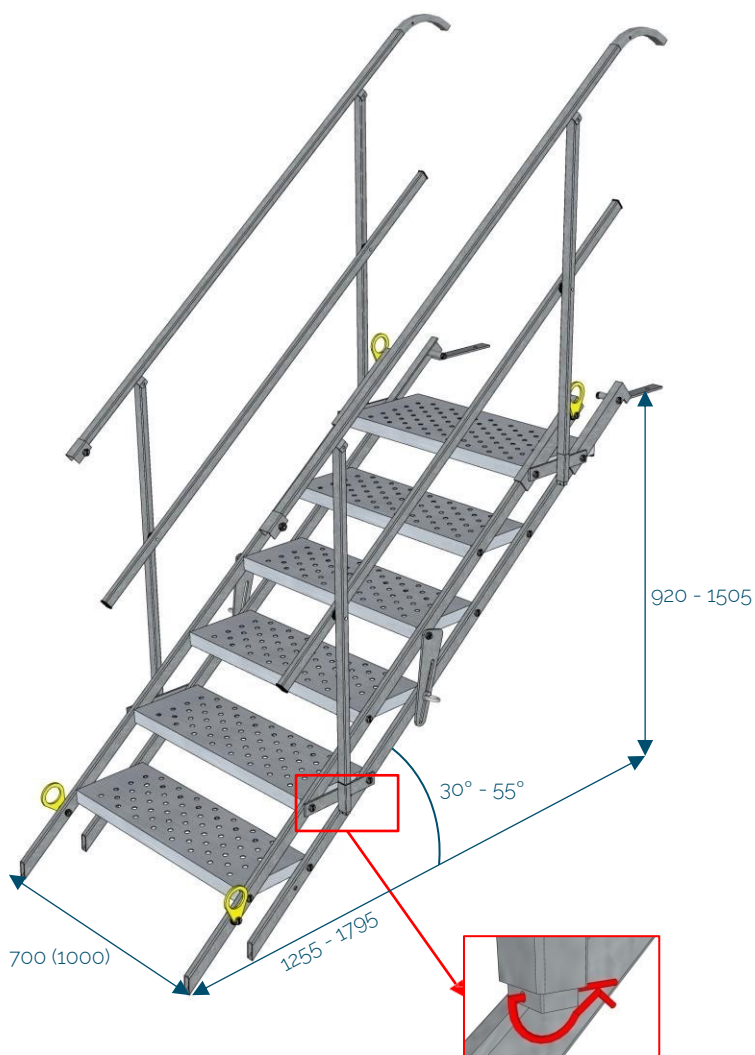

Rangement alterné des escaliers

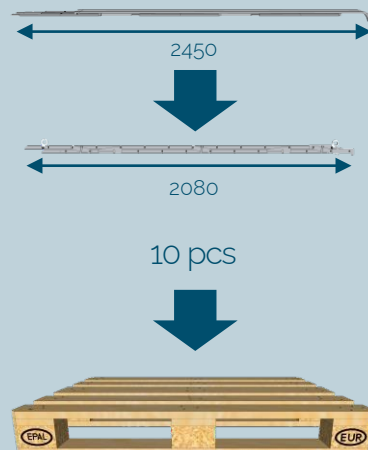

→ Escalier 700 : 650 kg
→ Escalier 1000 : 750 kg

Composants

N212-015 (N212-017)	Marche simple escalier 700 (1000)	5 pcs	N212-023	Fixation de garde- corps	4 pcs
N212-016 (N212-018)	Marche palière escalier 700 (1000)	1 pc	N212-019	Mécanisme de verrouillage	2 pcs
N212-029	Limon latéral escalier 6 marches	1 set (4 pcs)	N212-025	Anneau de levage	4 pcs
N212-002	Garde-corps escalier 6 marches	2 pcs	N212-021	Fixation de dalle	2 pcs

[mm]

